

Box contents

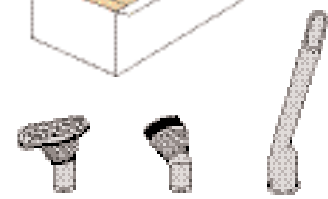

Important information

- Please see the back of the manual for optional accessories.
- If you have any questions, please call the Dyson helpline on 08705 275104 or log on to www.dyson.co.uk

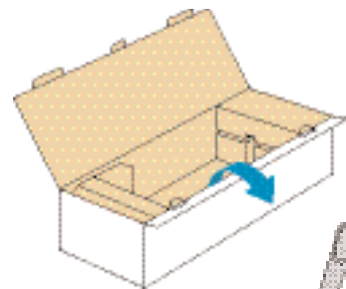

Stair tool Brush tool Crevice tool



Optional: Mini turbine head

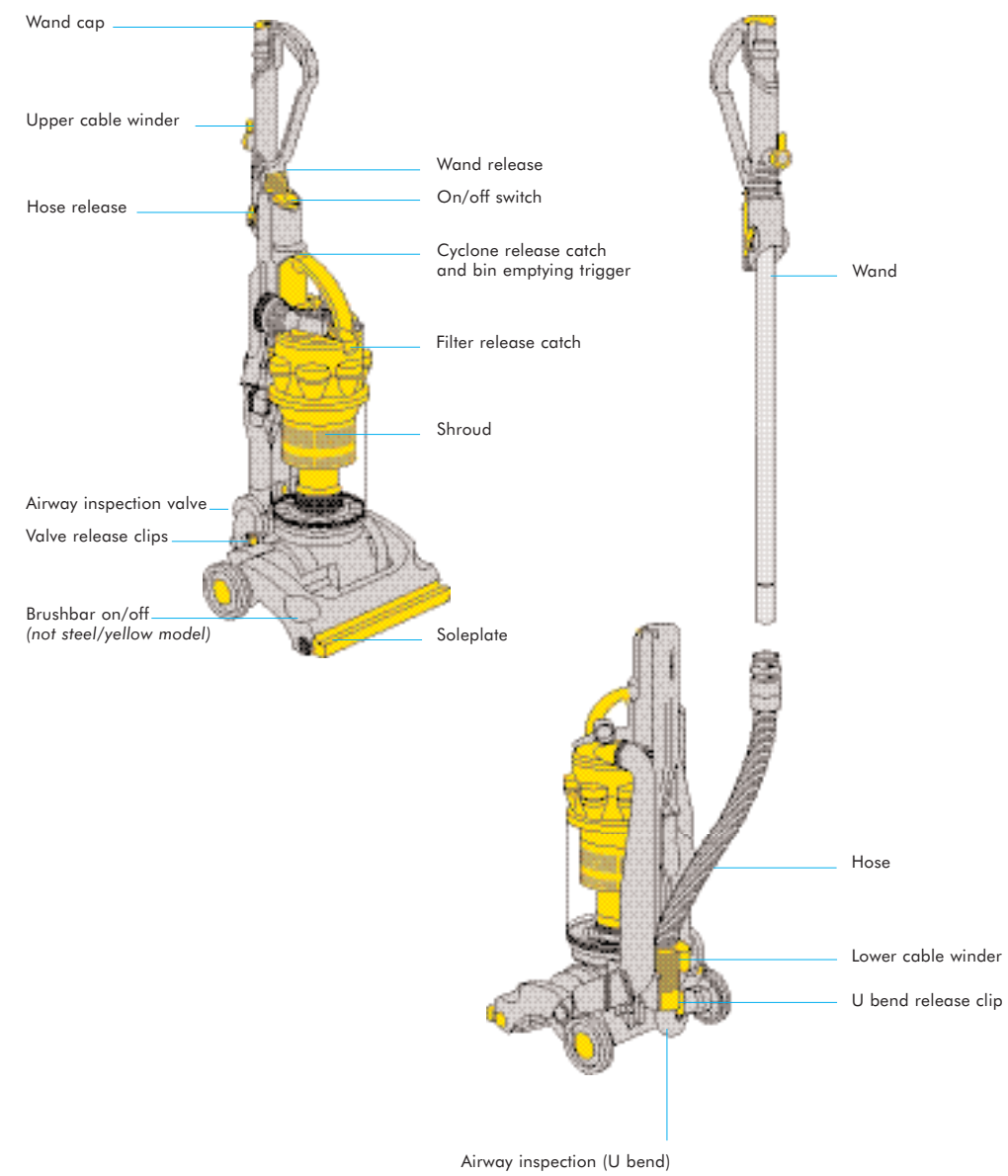
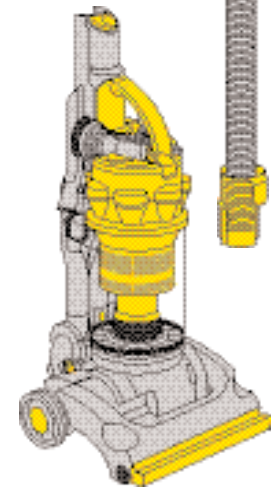

Assembling your Dyson

Important information

- Ensure the wand cap cover is closed.
- Ensure hose is kept straight when inserting wand into hose.

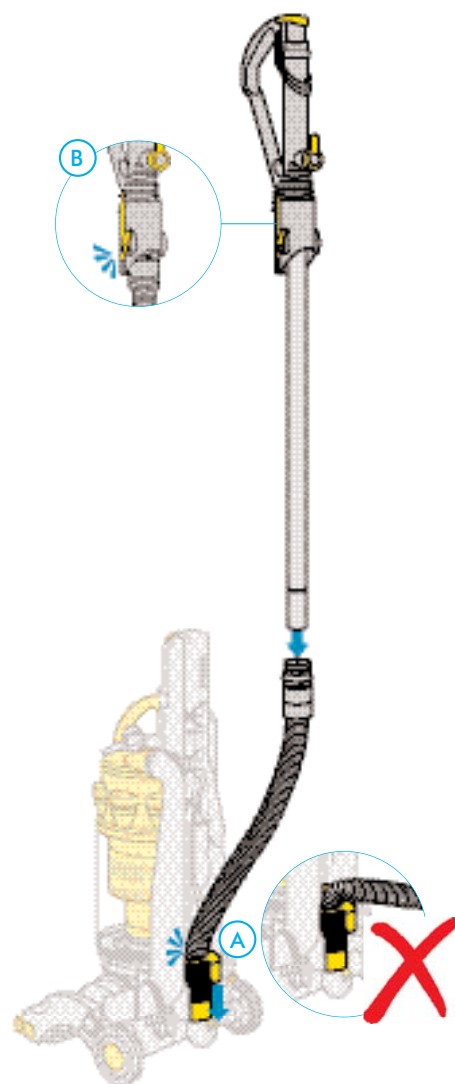

A Slide hose into runners at back of machine and click into place.

B Slide wand straight down in to hose until it clicks into place.

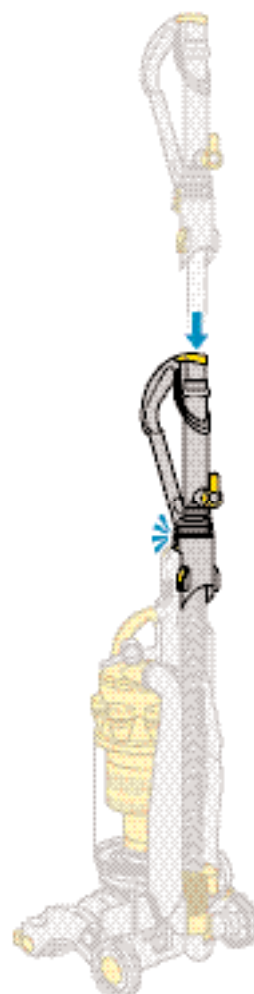

Click wand handle into top of machine.

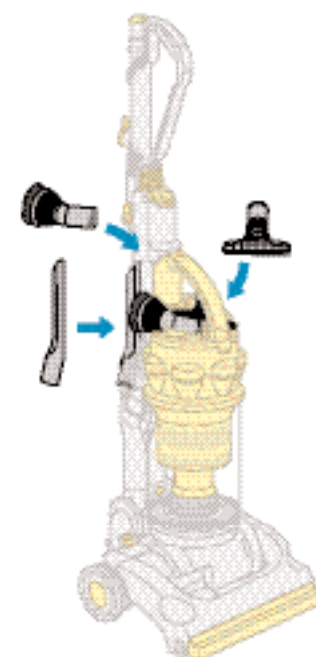

Click tools into place.

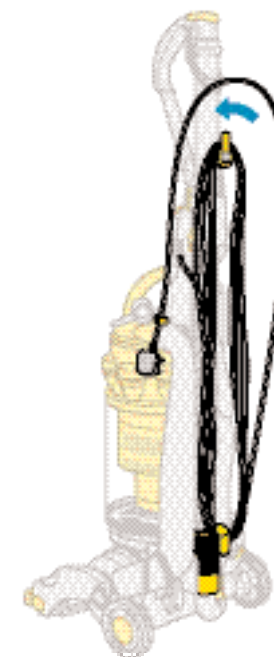

Wind cable anti-clockwise around cable winders and secure with clip.

Using your Dyson

Important information



- The machine is intended for domestic use only.
- Fine dust such as plaster dust should only be vacuumed in very small amounts.
- **Do not** press the cyclone release catch whilst carrying the machine.
- Ensure the cyclone pack is secured to the machine.
- **Do not** shake the machine whilst carrying.
- Keep hair and loose fabrics away from wand cap when machine is on.

Anti-jam brushbar (not steel/yellow model)

DC14 steel/yellow is not suitable for hard floors, as the brushbar cannot be turned off.

We recommend brush control models for homes with mixed flooring.

Ensure the machine is in an upright position before adjusting the setting.

- For hard floors 
- For carpets 

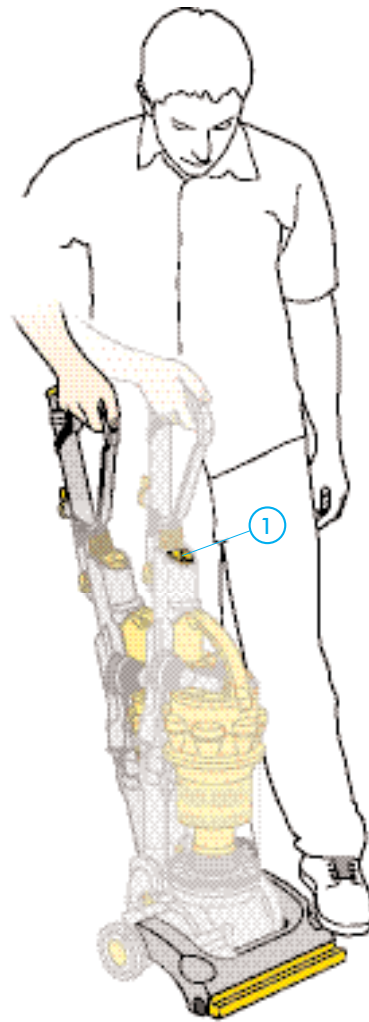
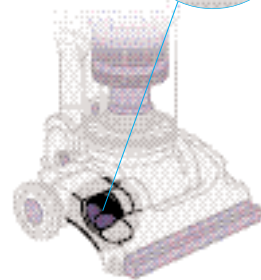

Press on/off button **1**, push cleaner head down with foot and pull handle towards you.

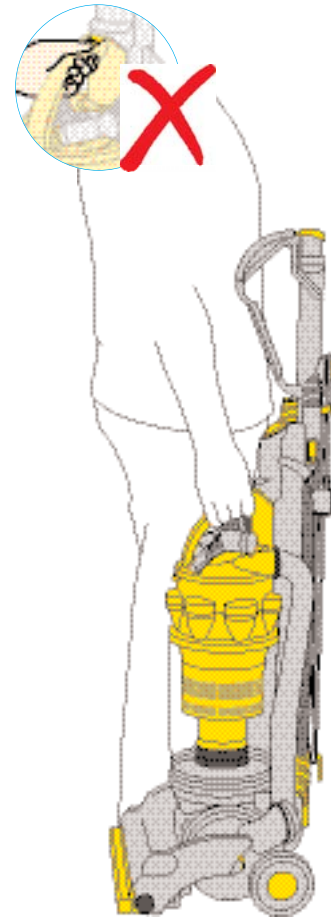

Use the carry handle to lift the machine.

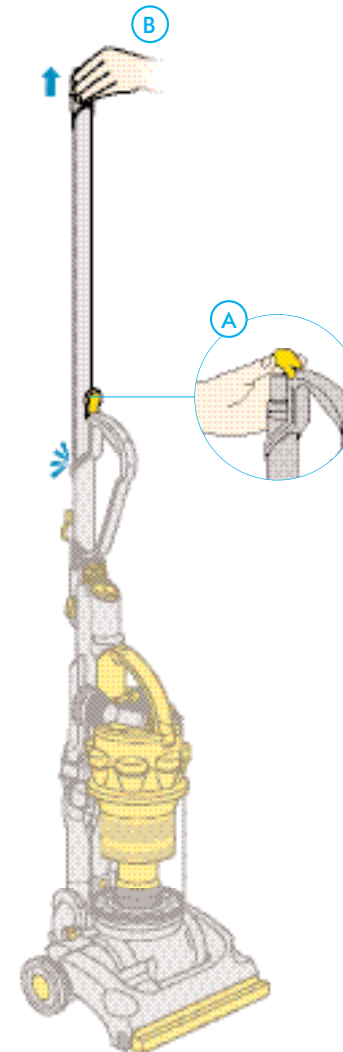

Tools

- A** Push back wand cap.
- B** Pull wand from inside wand handle until it locks into place.

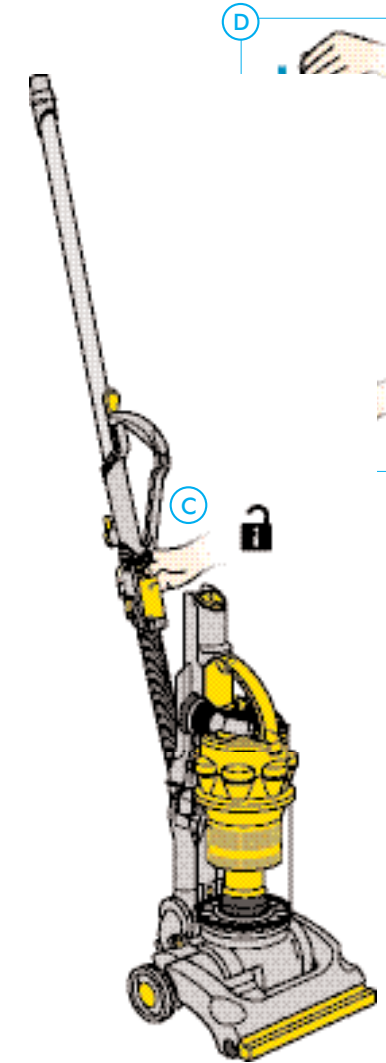

- C** Press button to release hose and wand handle from machine.
- D** To push wand back inside hose, ensure hose is straight. Press the release catch and push wand back inside wand handle.

Using your Dyson

Important information

- Powerful suction can cause the hose to 'pull back' in use – please take care when cleaning stairs.

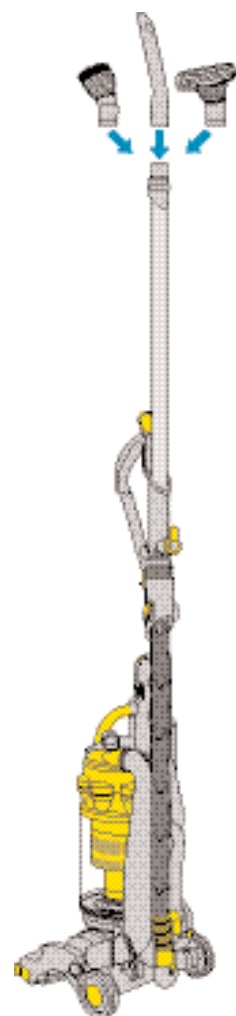

A Tools can be fitted directly to the end of the wand and hose for hard to reach places.

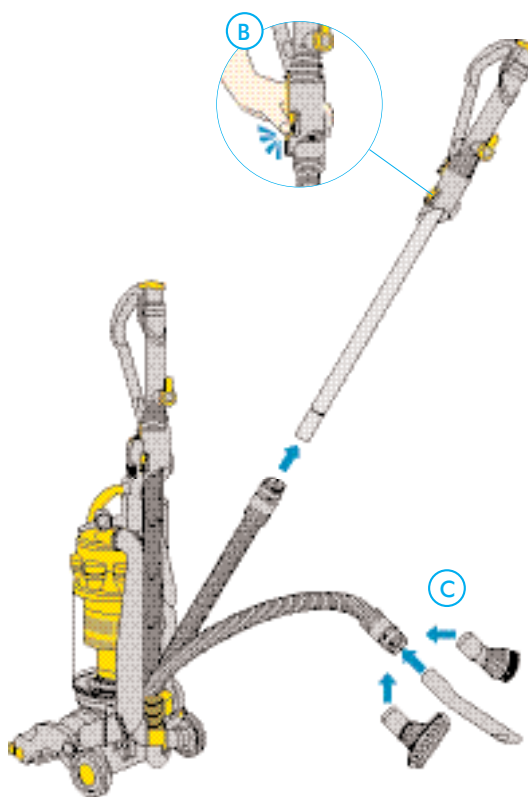

B With wand extended, press side buttons to remove wand handle from the hose.

C The tools can be fitted directly to the end of the hose.

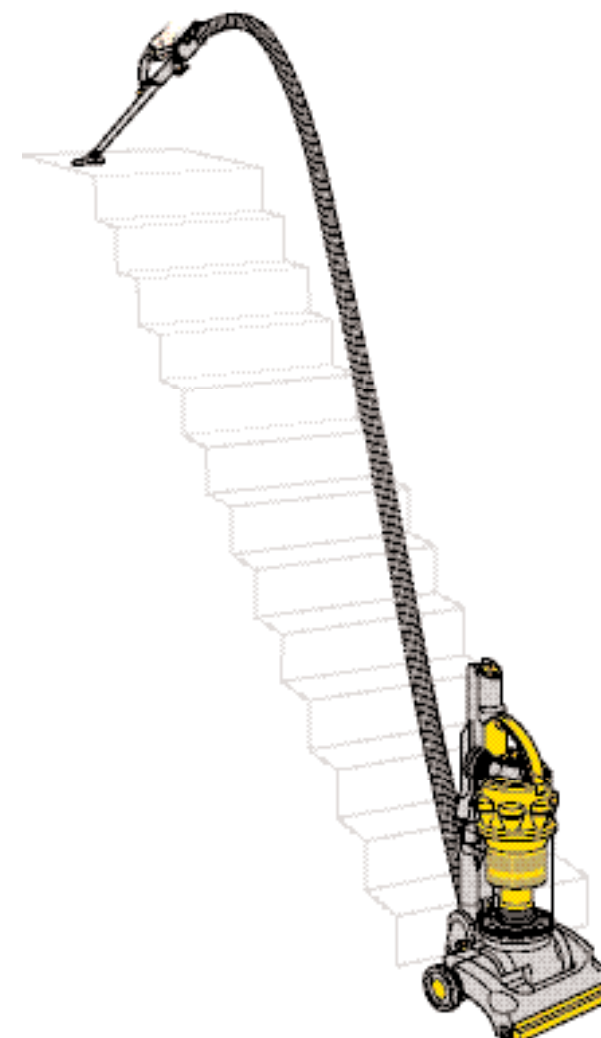

Always work with the machine at the bottom of the stairs.

Emptying the clear bin™

Important information

- Turn power off and unplug before emptying the bin.

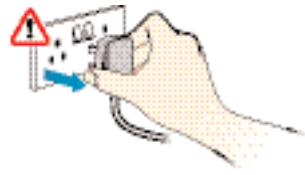

- Do not use the machine without the clear bin™ in place.



The British Allergy Foundation considers that this product may in proper use reduce exposure to both House Dust Mite (Der p 1) and Cat Allergen (Fel d 1). It is strongly recommended that a sensitive person should take care when emptying the clear bin™. We recommend the manufacturers' emptying instructions should be strictly followed.

Assessment carried out by BAF indicate that an individual's exposure can be reduced but this does not mean that an individual's allergic symptoms will necessarily diminish. BAF's opinion applies only to the products and allergen stated. The product should be used only for its intended purpose and strictly in accordance with the manufacturers' instructions at all times.

Exposure to allergens can be dangerous. If you believe that you may suffer from an allergy you should seek medical advice. The British Allergy Foundation is a national charity (Charity Reg. No. 1003726) founded in 1991 with the aim of improving awareness, prevention and treatment of allergy.

The Foundation continually strives to help sufferers to help themselves, often seeking to avoid or reduce exposure to relevant allergens. The Seal of Approval scheme forms a part of this initiative.

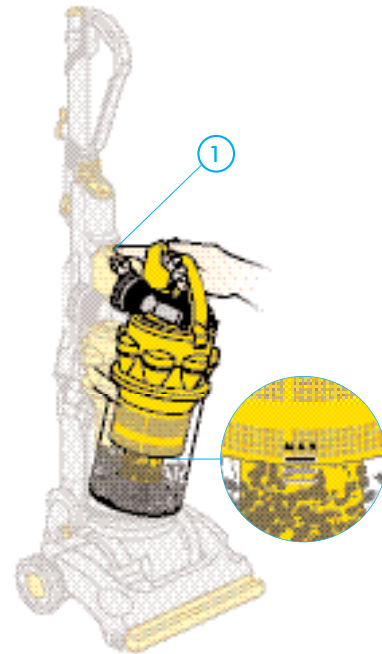

Empty the clear bin™ as soon as the **MAX** mark is reached. Press catch **1** to release cyclone from machine.

Option A

Push the button as shown to release the bin base and empty directly into dustbin.

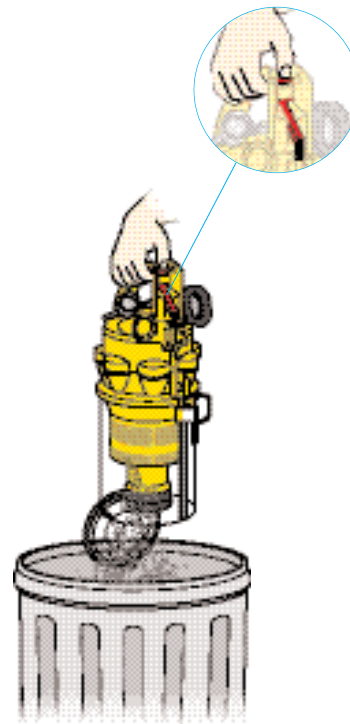

Option B

Emptying in a bag is recommended for allergy sufferers. Place bin in bag and pull trigger to release bin base.

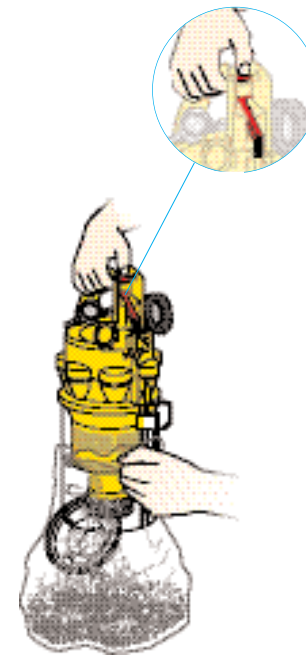

Let the dust settle, close bin base securely before removing from bag.

Close bin base securely and place back onto machine.



Cleaning the clear bin™

Important information

- Do not use detergents, polishes or freshening products. 
- Do not immerse the cleaner in water.
- Ensure the bin is completely dry before refitting.

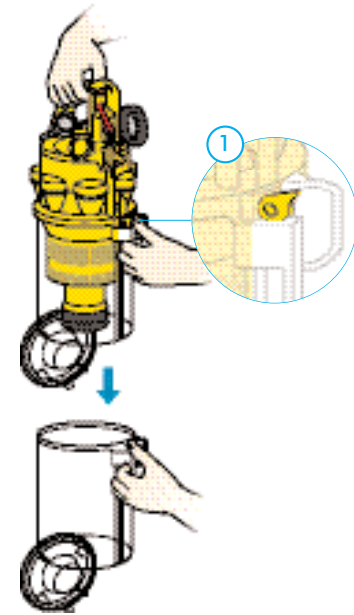

Cleaning the shroud (if necessary)
 Ensure the bin has been emptied and bin base is open.
 Press catch 1 to release clear bin™



Clean shroud with a cloth or small brush to remove fluff or debris.

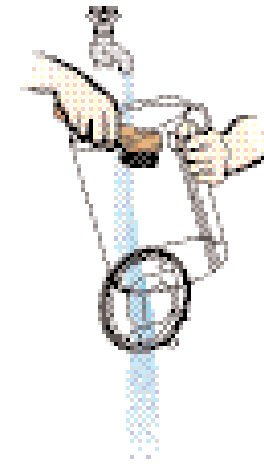

Cleaning the clear bin™

- Do not use detergents, polishes or freshening products.
- Do not immerse the whole cleaner in water.
- Ensure the bin is completely dry before refitting.

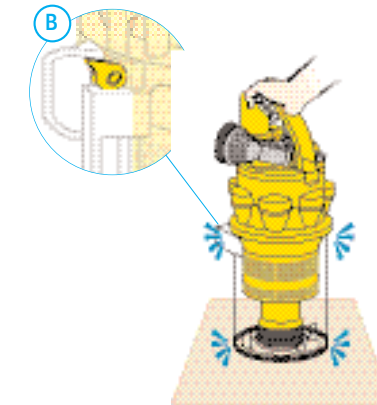
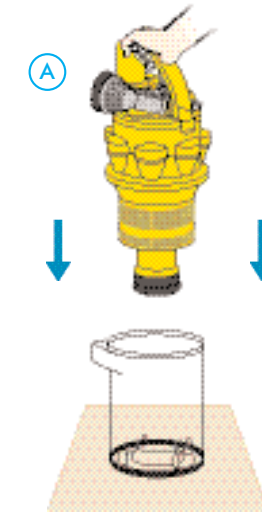

Replacing the shroud

A Hold the carry handle and place the cyclone into the clear bin™

B Line up the catches and push down to click in to place. Ensure the clear bin™ is secure before replacing on the machine.

Washing the filter at least every 6 months

⚠ Important information

Turn power off and unplug before emptying the bin.



Do not use the machine without the filter in place.

Do not use detergent.

Do not put the filter in the dishwasher, washing machine, oven, tumble dryer, microwave or near a naked flame.



The filter may require washing more frequently if vacuuming fine dust. Press catch **1** to release cyclone pack.

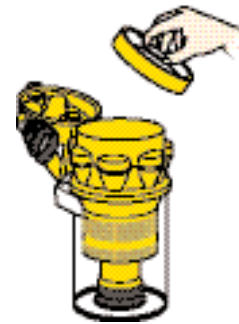
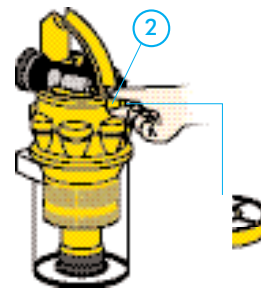

Accessing the filter

Lift filter release catch **2** and remove filter from machine.

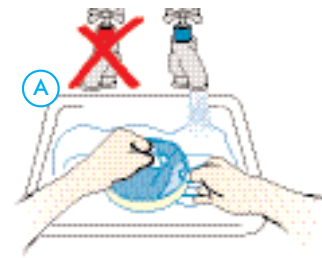

A Washing the filter

- Wash filter and case in cold water only.
- Only wash blue foam and yellow cage.
- Do not use detergent.
- Do not put in washing machine or dishwasher.
- Do not put the filter in the dishwasher, washing machine, oven, tumble dryer, microwave or near a naked flame.

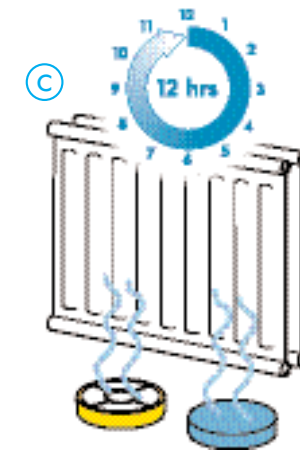

B Wash filter and case until water runs clear.

C Dry for at least 12 hours.

Ensure filter and case are completely dry before refitting onto the machine.

Finding blockages

Important information

Turn power off and unplug before emptying the bin.



If any part of your machine becomes blocked, it may overheat and then cut out. Unplug machine and leave to cool down.

Please note: Clearing blockages is not covered by your machine's guarantee. *(Keep your proof of purchase safe.)*

Beware of sharp objects when clearing blockages.

Secure all parts before using the machine.

The ratchet noise warns you that the brushbar is obstructed.

Disconnect the machine before removing the obstruction.

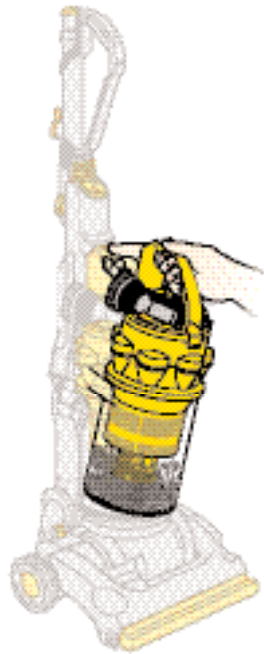

Check tools are clear of blockages.

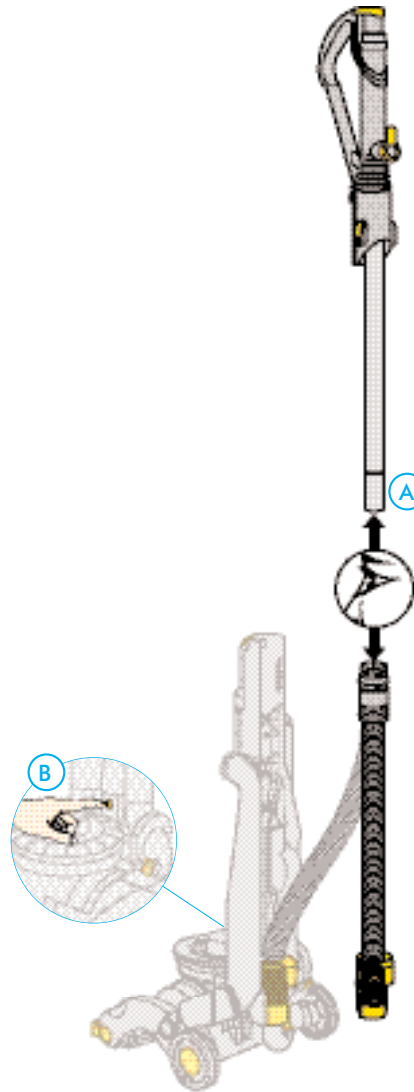
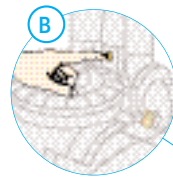

- A** Remove wand and check inside wand and hose for blockages.
- B** Press hose release button at front of machine and slide hose out with lower cable winder at rear.

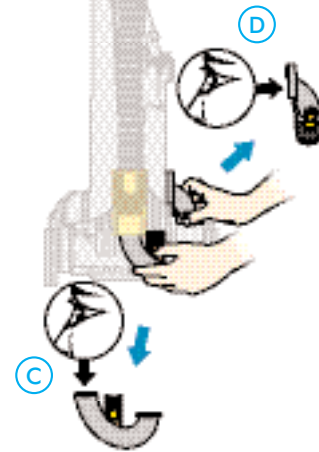

- U bend inspection**
- C** Tilt machine forward, slide out U bend and check inside for blockages.
- Airway inspection**
- D** Squeeze valve release catches and check inside for blockages.

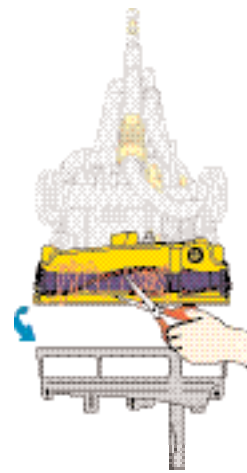
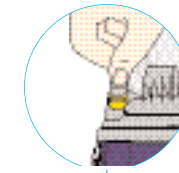

- Brushbar obstructions**
- Lie cleaner on its front.
- Undo fasteners using a coin and remove soleplate.
- Remove fluff and hair from brushbar.
- Replace soleplate and tighten fasteners.

Changing/fitting the belt (steel/yellow model only)

Important information

Turn power off, unplug machine and allow machine to cool for 1 hour before changing/fitting belt.



Ensure soleplate is in correct position before use.



Remove wand and turn machine upside down.

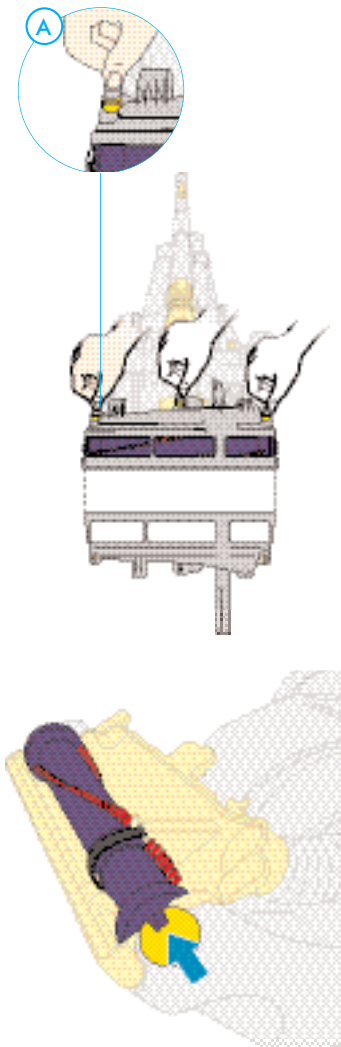

A Undo fasteners using a coin, slide back end caps and remove soleplate.

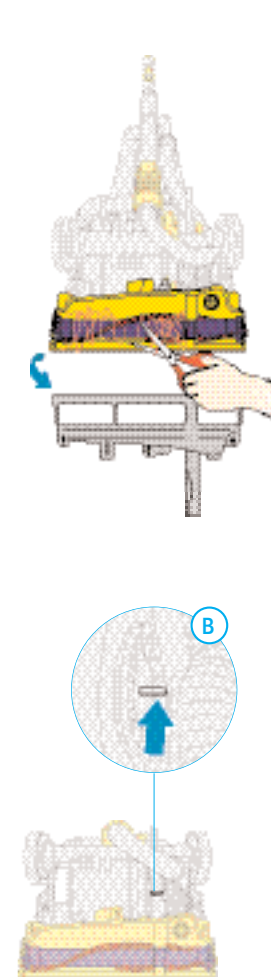

B Remove dirt or debris and check spindle is clean.

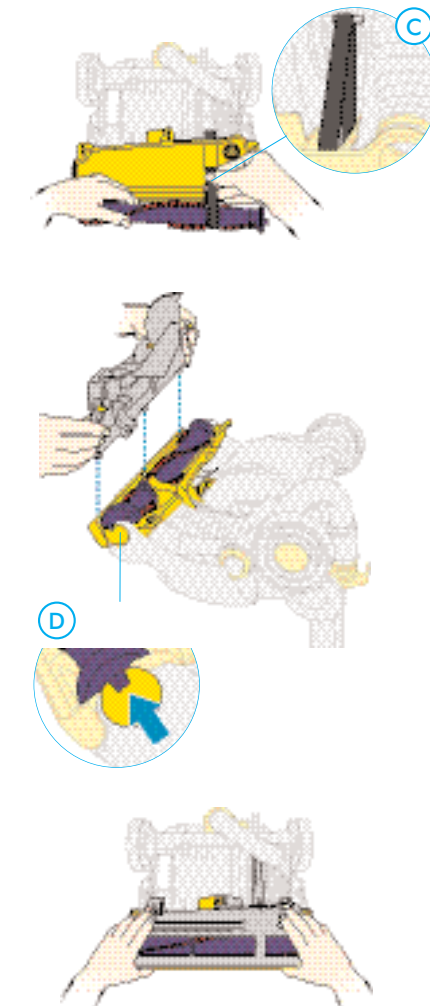

C To replace the belt, remove the brushbar, loop belt around brushbar and feed through hole.

D Check end caps are in place.

Changing/fitting the belt (steel/yellow model only)

Important information

Ensure soleplate is in correct position before use.

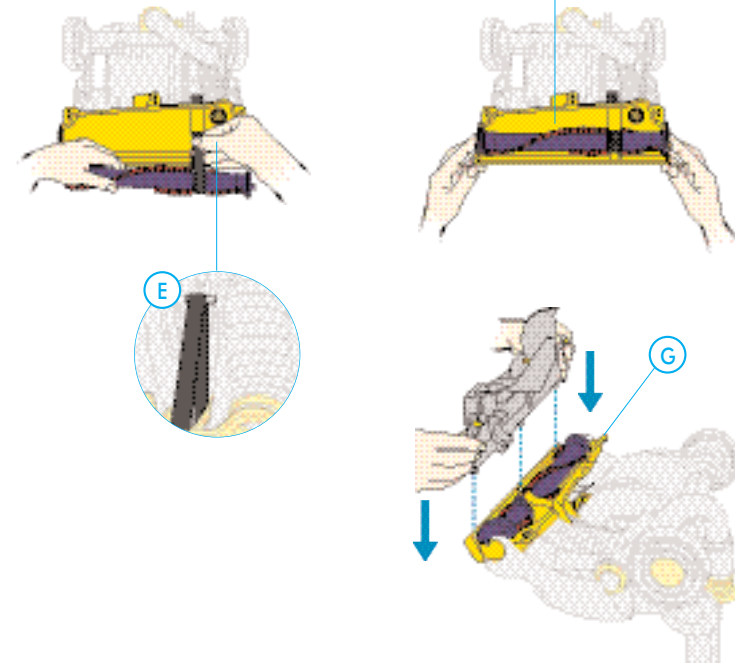

E Use back of cleaner as lever, loop belt around thumb. Turn the belt 90 degrees, stretch and release over spindle. Belt must be free of twists as shown.

F Rest the three tabs on inside of yellow bumper strip and secure soleplate back into position.
G Ensure soleplate is in correct position before use.

Optional: maintaining the Mini turbine head

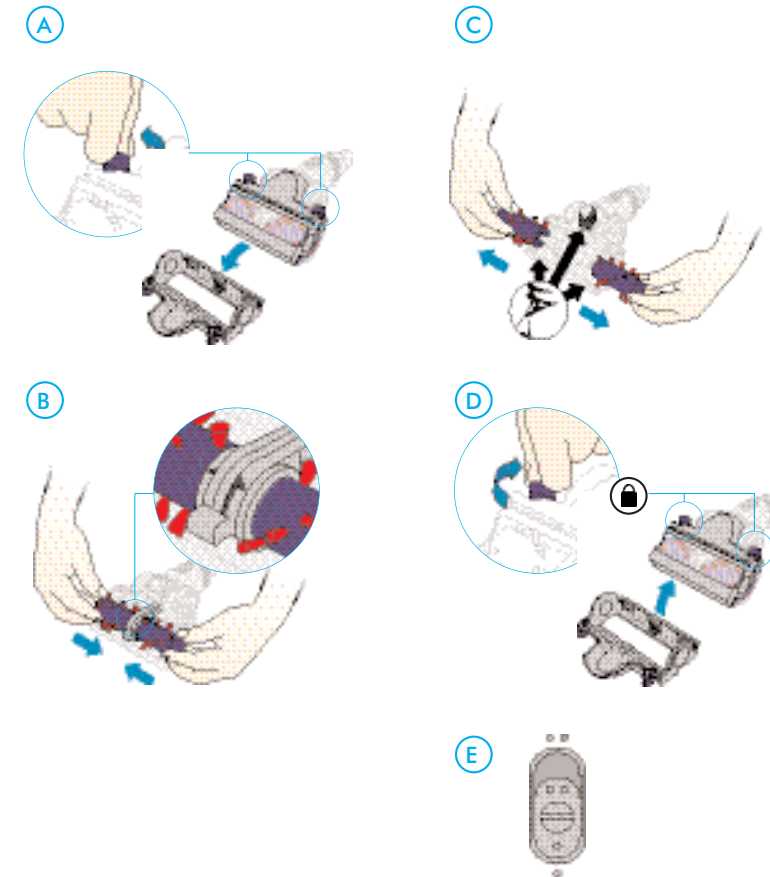

Optional: Mini turbine head
A Release catches and remove the soleplate.
B Remove both brushbars and clear away thread and hair.

C To reassemble, match the arrows on the brushbar to the arrows on central support.
D Align front of soleplate with front of tool and secure all 3 catches.
E Ensure slider is set as shown.

Dyson customer care

Important information

If you have a query about your Dyson, call the Dyson helpline with your serial number (found underneath your machine).

Important Information

Check that your electricity supply corresponds to that shown on the rating plate. The machine must be used as rated.

If the supply cord or the appliance is damaged, disconnect from the socket outlet immediately. The supply cord must be replaced by Dyson Ltd or our appointed agent to avoid a hazard.

This appliance is not intended for use by young children or infirm persons without supervision.

Young children should be supervised to ensure that they do not play with the appliance.

Do not use the cleaner if the cable or plug are damaged or if the cleaner has been damaged, dropped or has come in to contact with water or any other liquid. In these cases, contact the Helpline.

When vacuuming, certain carpets may generate small static charges in the clear bin. These are entirely harmless and not associated with the main supply. To minimise any effect from this, do not put your hand or insert any object in to the clear bin unless you have emptied it and rinsed it out with cold water.

Do not use the cleaner if any parts appear to be faulty, missing or damaged.

Do not carry out any maintenance work other than that shown in this manual or advised by the Helpline and do not put anything in to the openings or moving parts of the machine.

Only use parts recommended by Dyson; failure to do so could invalidate your guarantee.

European conformity information

A sample of this product has been tested and found to be in conformity with the following European Directives: 73/23/EEC Low voltage (safety) Directive, 93/68/EEC CE Marking Directive, 89/336/EEC EMC Directive.



Do not pull on the cable.



Do not use above you on the stairs.



Do not put your hands near the brushbar when in use.



Do not use near naked flame.



Do not leave cleaner near heat sources.



Do not pick up water or liquids.



Do not run over the cable.



Do not pick up burning objects.

PATENTS AND PATENT APPLICATIONS

US10/468,870	EP1121043	JP2001-572220
JP2002-567124	JP2000-575409	US10/239,426
EP1361812	US6,572,078	AU2002-225232
AU2002-567124	AU757043	EP1361815
GB2393383	EP1052923	GB2372435
PCT/GB2003/004058	JP2000-523902	JP2002-567134
PCT/GB2003/003928	US6,691,849	US10/468,304
AU744408	GB0326102.1	GB2372436
EP1119282	AU2002-226556	AU637,272
JP2000-575411	EP1370172	EP0636338
US6,519,807	JP2002-567120	JP1,948,863
AU2002231965	US10/468,676	US5,078,761
EP1361813	AU2002-225207	
JP2002-567126	EP1361814	
US10/468,653	JP2002-567129	
AU744362	AU2001-240894	
	EP1268076	
	GB2360719	

REGISTERED DESIGNS AND DESIGN APPLICATIONS

AU154578	GB3012888	US29/193,623
EP00090865	JP2003-34801	GB3015739

DC14 accessories

The items can be used with your DC14. For further information visit the Dyson website www.dyson.co.uk



Mini turbine head

For improved pick up of pet-hair from upholstery and stairs.



Flexi crevice tool

Extends and flexes into awkward gaps.

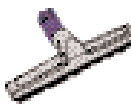

Hard floor tool

For improved pick-up on hard floors.



Cleaning Pack

1. Groomer

Long bristles work zorb carpet maintenance powder deep into carpets.

2. Zorb carpet maintenance (750g)*

Millions of tiny sponges absorb dirt from the carpet, to keep new carpets looking new with none of the drawbacks of wet cleaning.

3. Dyzolv spot cleaner (230ml)*

Contains 4 active agents to clean spots and spills e.g grease, food, drinks and soil. Ideal for wool and stain resistant carpets and rugs.

Dyson Customer Care

Every new Dyson domestic vacuum cleaner has a 2 year guarantee.

If you have a query about your Dyson, call the Dyson Customer Helpline with your serial number and details of where/when you bought the cleaner.

Most queries can be solved over the phone by one of our trained Helpline staff.

If your cleaner needs attention from our engineers, we aim to have it repaired and tested within 3 working days.

Your serial number can be found on your rating plate which is underneath the machine beneath the wheels.



Note your serial number for future reference:



UK 08705 275 104

7 days a week 8am - 8pm

e-mail: service@dyson.com

Tetbury Hill, Malmesbury, Wilts SN16 0RP

IRL (01) 475 7109

Visit the Dyson website for product information and to order accessories and spares.

www.dyson.co.uk

dyson

DC
14

User Guide
Please read this carefully before use

