

Important

Check both electrostatic filters whenever the bin is emptied and replace at least every **3** months.

Please note that if the filters are not checked regularly and changed as required, the motor may overheat, which will cause the thermal cut-out to operate.

NOTE: Vacuuming builder's dust and some carpet fresheners may cause the filters to require changing more frequently. (Dyson does not recommend the use of carpet fresheners).

Replacement filters are available from your local retailer or direct from Dyson. Call or fax the Helpline for orders.

IMPORTANT: Use only genuine Dyson filters, which have been tested and approved for this cleaner.

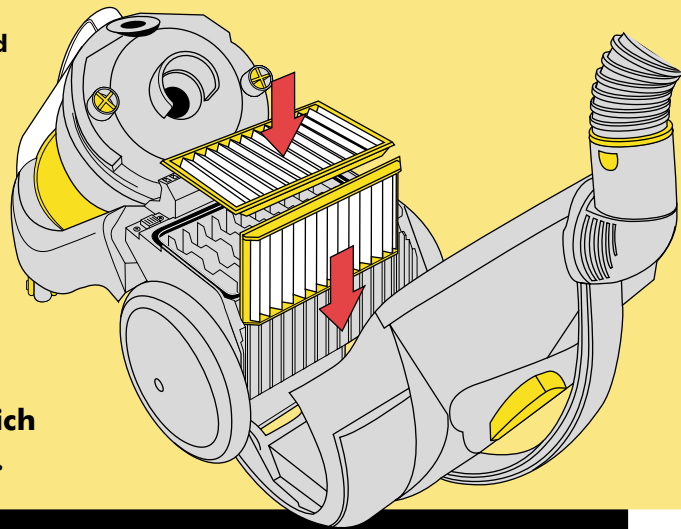
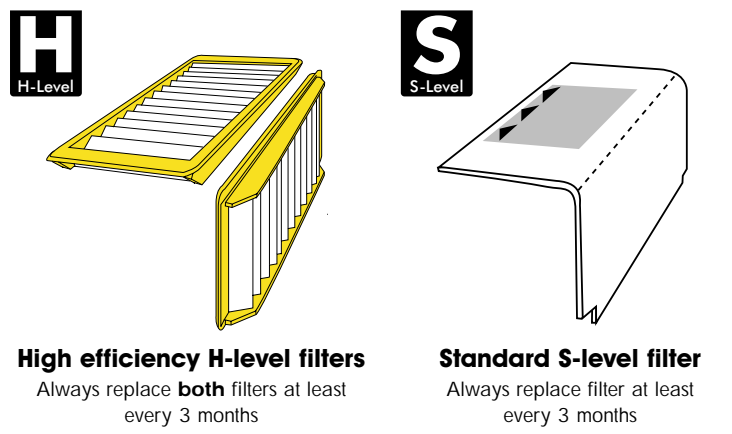

NOTE

Your Dyson has a built-in thermal cut-out to protect it in the event of a restriction to the airflow and may suddenly stop working temporarily if you do not change the filters at the stated time, or if blockages are not cleared immediately.

If the vacuum cleaner suddenly stops working (ie. the motor makes no sound when switched on) then please check your cleaner for blockages as

detailed in this operating manual. (Remember also to check the fuse in the plug). Having established that there are no blockages and that the filters have been replaced within the stated time, leave your vacuum cleaner unplugged for 60 minutes and then try using it again.

If the vacuum cleaner still does not work, please call Dyson Customer Care (Tel: 01666 827272).

IMPORTANT ALWAYS UNPLUG THE VACUUM CLEANER FROM THE WALL SOCKET BEFORE INSPECTING IT

NOTE

Check that your supply corresponds to that shown on the rating plate. The appliance must only be used as rated, it should be fitted with an ASTA approved fuse to BS1362.

European conformity information A sample of this product has been tested and found to be in conformity with the following European Directives: 73/23/EEC Low voltage (safety) Directive, 93/68/EEC CE Marketing Directive and 89/336/EEC EMC Directive.

For your convenience this appliance is supplied with a plug which is fitted with a 13amp fuse of the appropriate rating.

Never put the plug into the socket outlet without the fuse cover fitted. Replacement fuse covers are available from Dyson Customer Care. If the plug supplied is not suitable for your socket outlet, it should be cut off and destroyed/safely disposed of. **Warning: Under no circumstances should the severed plug be inserted into a 13A socket, serious danger of electric shock would result from the exposed wires.**

The mains lead can then be shortened to the minimum required length, suitably prepared and the correct style of plug to suit your household wiring system should be fitted. The following wiring instructions should be followed. **If in doubt, consult a qualified electrician.**

Unwanted products and the environment Should you find that your product needs replacing one day, or is of no further use to you, think of protecting the environment. Dyson will accept your old products and recycle them in an environmentally friendly way.

IMPORTANT

The wires in the mains lead are coloured in accordance with the following codes.

Brown - Live

Blue - Neutral

As the colours of the wires in the mains lead may not correspond with the colours or markings identifying the terminals in your plug, proceed as follows:

The wire which is coloured **Blue** must be connected to the terminal which is marked with the letter **N** or coloured **Black**.

The wire that is coloured **Brown** must be connected to the terminal which is marked with the letter **L** or coloured **Red**.

Neither wire should be connected to the earth terminal of a three pin plug which is marked with the letter **E** or \perp or coloured **Green** or **Green and Yellow**.

Always ensure that the cable clamp is fitted and that it clamps the cable outer and **NOT** the coloured wires.

If the supply cord of the appliance is damaged, disconnect the appliance from the socket outlet immediately. The supply cord must be replaced and only by Dyson Appliances Ltd. or their appointed agent as special purpose tools and service techniques are required.

dyson

dual cyclone
TECHNOLOGY

Helpline 01666 827272
Facsimile 01666 827298
Contact for all service assistance

DYSON CUSTOMER CARE
TETBURY HILL
MALMESBURY
WILTSHIRE
ENGLAND
SN16 0RP

dyson

dual cyclone
TECHNOLOGY

**DC
02**

Operating manual

Please read carefully before assembling or using your DCO2 vacuum cleaner.

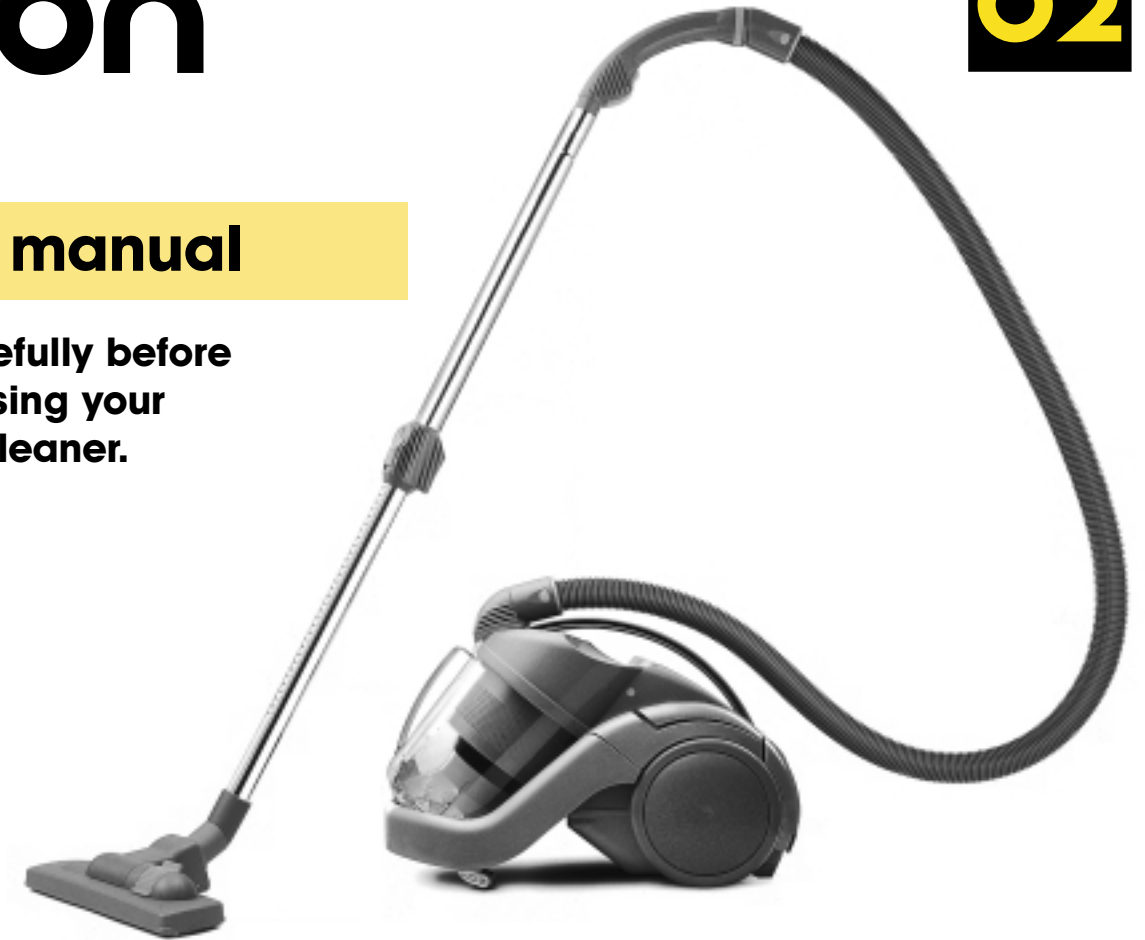

Important safety instructions – please read before use

WHEN USING THE DYSON DCO2 VACUUM CLEANER PLEASE ADHERE TO THESE SIMPLE PRECAUTIONS. BY DOING SO YOU WILL REDUCE THE RISK OF FIRE, ELECTRICAL SHOCK OR INJURY.

1. Do not leave your Dyson cleaner with the plug connected to a mains outlet – unplug when not in use. Turn the cleaner off with the switch button before removing from the mains outlet.
2. Always remove the plug from a mains outlet before carrying out any maintenance. Do not carry out any maintenance work on the cleaner other than that outlined in this manual, especially where electrical components are concerned.
3. Do not use without the clear bin assembly fitted correctly and both filters in place.
4. Do not fit anything other than Dyson spare parts (available on the Helpline on 01666 827272). Use of non-Dyson parts could invalidate your guarantee.
5. Do not continue to use the cleaner if any part appears to be faulty, missing or damaged. In these cases, contact the Dyson Helpline on 01666 827272.
6. Do not put any part of the body, clothes or any object near or into the openings or moving parts of the machine. Do not use the machine with any of the openings blocked with any object that may restrict the airflow.
7. Do not pull on the supply cord, run over it or pull it around sharp edges or near/over hot surfaces. If damaged, call the Dyson Helpline. Do not handle the cleaner or plug with wet hands.
8. Do not use the cleaner if the cord or plug are damaged or if the cleaner has been damaged, dropped or has come into contact with water or any other liquid. In these cases, contact the Helpline.
9. Do not use the cleaner to pick up water or any other liquid. Electrical shocks could occur if used outdoors or on wet surfaces.
10. Do not use the cleaner to pick up flammable or combustible substances or hot ashes or burning objects of any kind. Do not use near such substances.
11. Do not work below the cleaner on the stairs.
12. Do not immerse the whole cleaner in water for cleaning. The clear bin alone may be washed out after emptying. Ensure this is completely dry before using the cleaner again.
13. Static charge can occur in many ways and, when vacuuming, certain carpets may generate small static charges in the clear bin. These are entirely harmless and are not associated with the mains supply. To minimise any effect from this, do not put your hand or insert any object into the clear bin unless you have first emptied and rinsed out the clear bin with water.

dyson

dual cyclone
TECHNOLOGY

Helpline 01666 827272
Facsimile 01666 827298
Contact for all service assistance

DYSON CUSTOMER CARE
TETBURY HILL
MALMESBURY
WILTSHIRE
ENGLAND
SN16 0RP

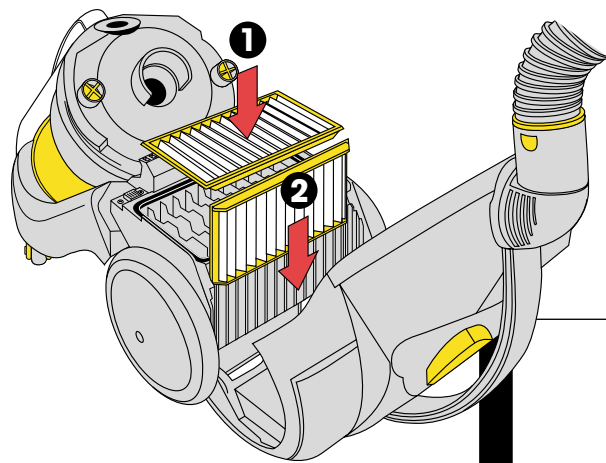

Changing filters

Your DCO2 is fitted with two high area H-level electrostatic cartridge filters. Alternatively a standard S-level filter may be purchased.

- 1 Insert top filter ensuring that it fits snugly against the black rubber seal on the machine.
- 2 Slide rear filter into the grooves and push it down fully. Fitting instructions for the standard S-level filters are printed on the filter itself.

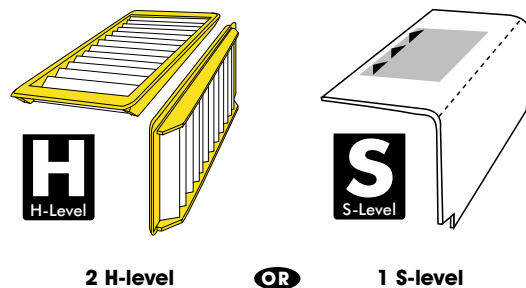

IMPORTANT Use only genuine Dyson filters.



Sits securely on the stairs

However, always work above the machine on stairs for your own safety.

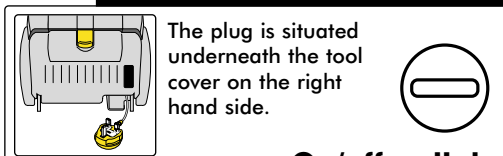

On/off switch

Press left switch.

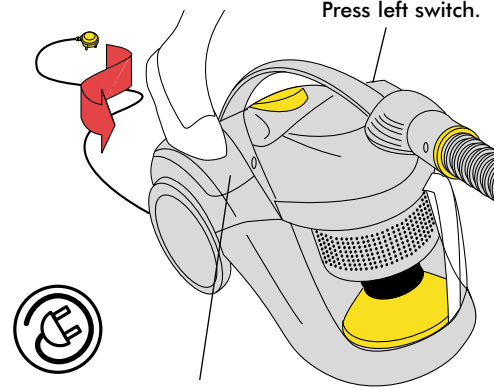

Cord rewind

Press right switch for cord rewind.

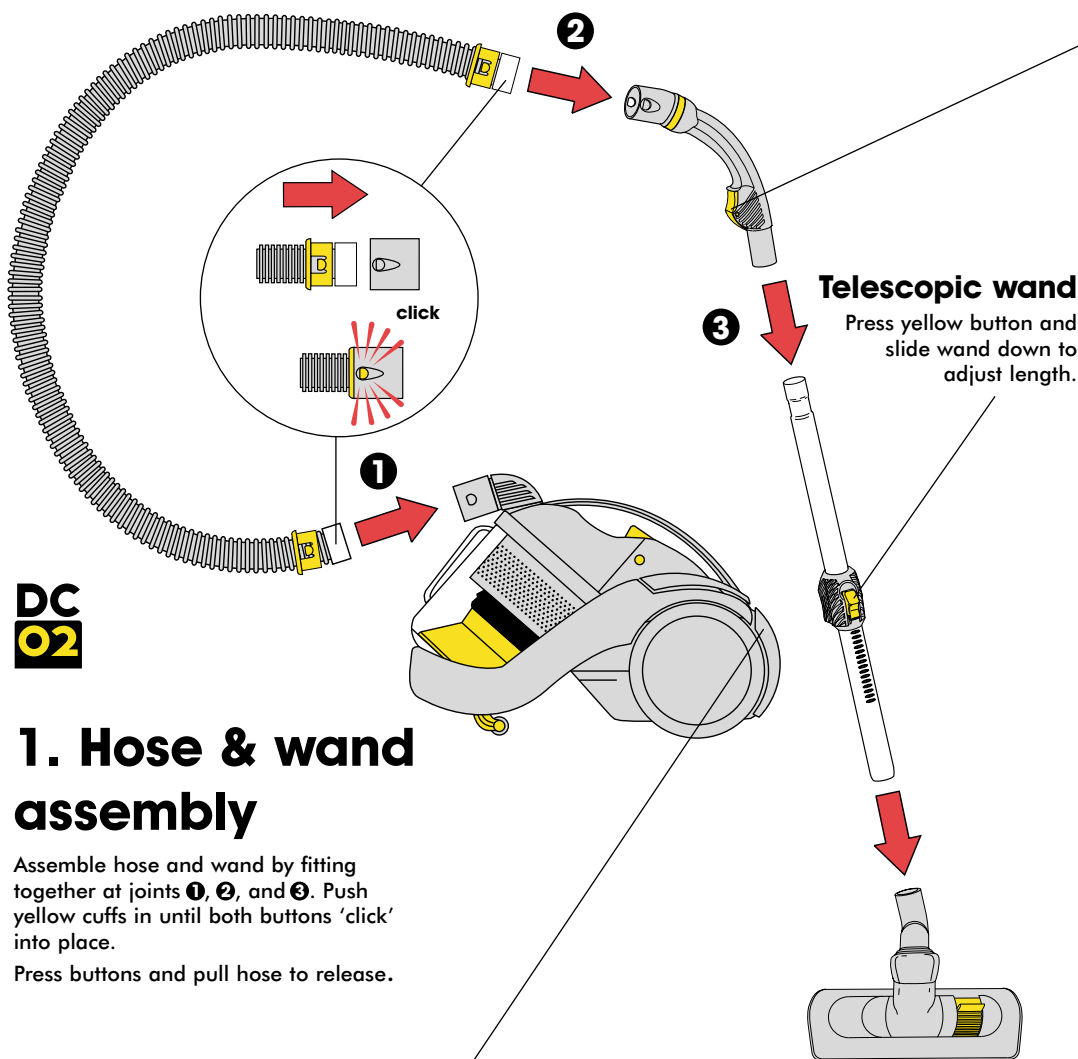

**DC
02**

1. Hose & wand assembly

Assemble hose and wand by fitting together at joints 1, 2, and 3. Push yellow cuffs in until both buttons 'click' into place.

Press buttons and pull hose to release.

Tool storage

Press yellow release catch to open the tool storage cover and insert required tool into end of wand or wand handle. Please note that tools may feel warm when machine has been running; this is perfectly normal.

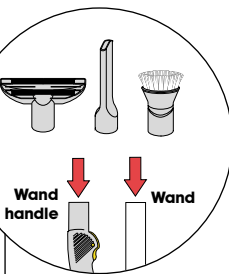
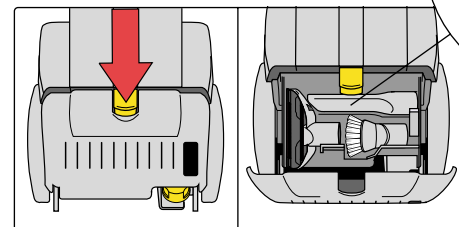

Self adjusting Floor tool

Fit floor tool by pushing firmly into end of wand.

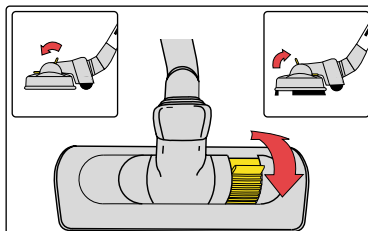

Height adjustment

Use selector to adjust to hard floor or carpet. Forward for carpets and back for smooth floors.

Automatic suction control trigger

Hold the yellow trigger down to reduce suction for upholstery and curtains.

To maintain reduced suction, press the trigger down hard until it clicks. To unlock and resume full suction, press down the opposite end of the trigger.

Blockage procedure

Please note: Any 'Blockage only' repairs will incur a charge of £35.00*. Please check your machine carefully. Check filters, replace if older than 3 months, or if filters are heavily coated with dust.

*Price correct at time of printing.



1. Check entry swivel 1 by pressing yellow buttons & pulling out hose. Clear any debris.

2. Check wand handle swivel 2 by pressing yellow buttons and pulling hose from wand. Clear any debris.

3. Check wand joint 3 by pulling wand and wand handle apart. Clear any blockage with rod or wire.

4. Remove floor tool from wand 4 and check for blockage.

5. Check air intake hole and check ramp.

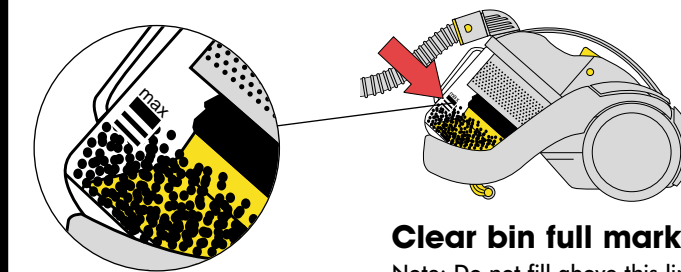
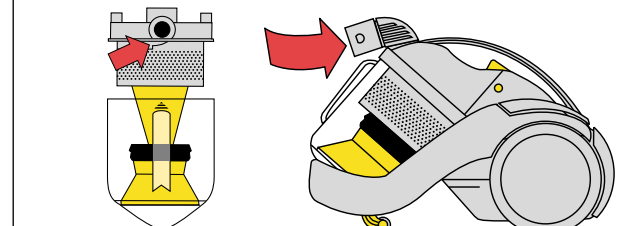

Clear bin full mark

Note: Do not fill above this line.

2. Clear bin removal

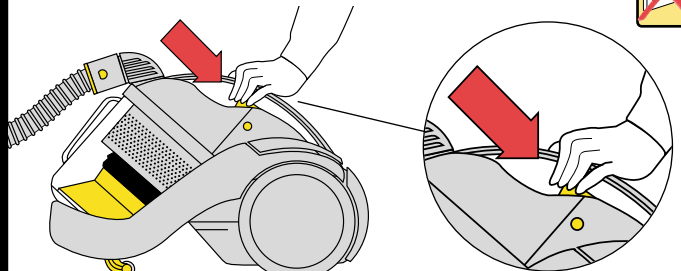

1 To empty clear bin, pull back release catch under carrying handle and raise top of machine.

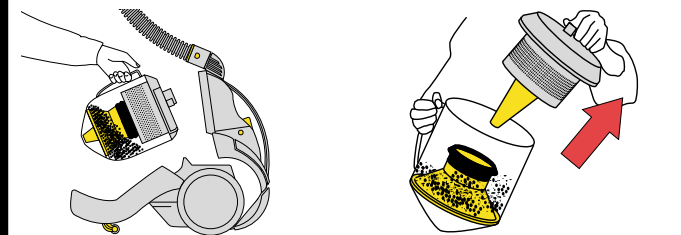

2 Lift clear bin out of machine. 3 Remove cyclone top (lid).

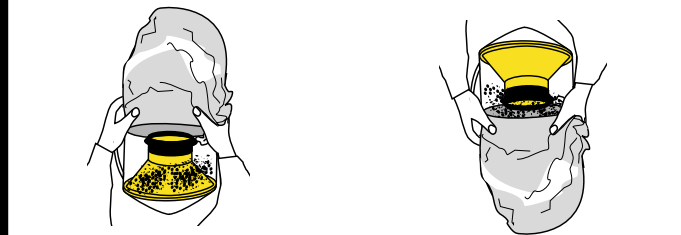

4 Wrap a plastic bag tightly around the rim of the clear bin. 5 Invert clear bin and wait at least 10 seconds before releasing.

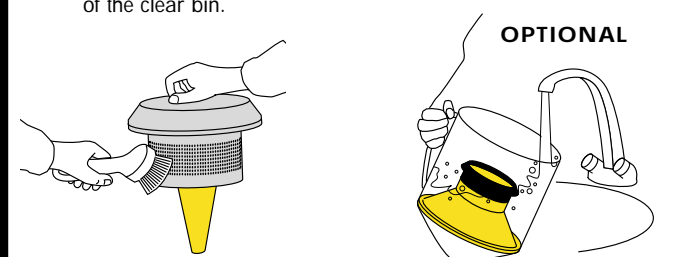

6 Wipe shroud holes free of all dust/debris. 7 Do not use strong detergents and ensure clear bin is fully dry before replacing in machine.

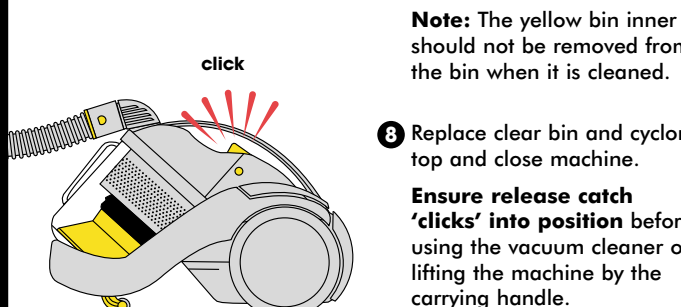

8 Replace clear bin and cyclone top and close machine.

Ensure release catch 'clicks' into position before using the vacuum cleaner or lifting the machine by the carrying handle.

